

Music Man JP w/Piezo BECOS Micro Booster Installation Wiring Diagram

Drawing by BECOS
www.becos.ro

PICKUP SELECTOR SWITCH

Neck Mix Bridge
UP DOWN

ON-ON-ON

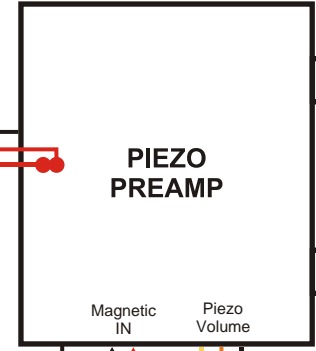
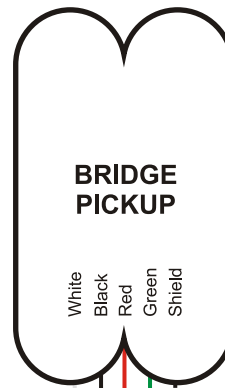
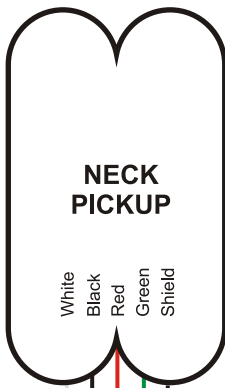
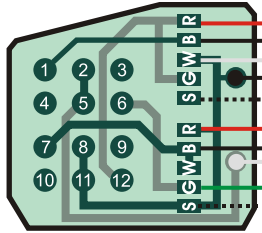

To metal cover



OUTPUT SELECTOR SWITCH

Piezo Mix Magnetic
UP

ON-ON-ON

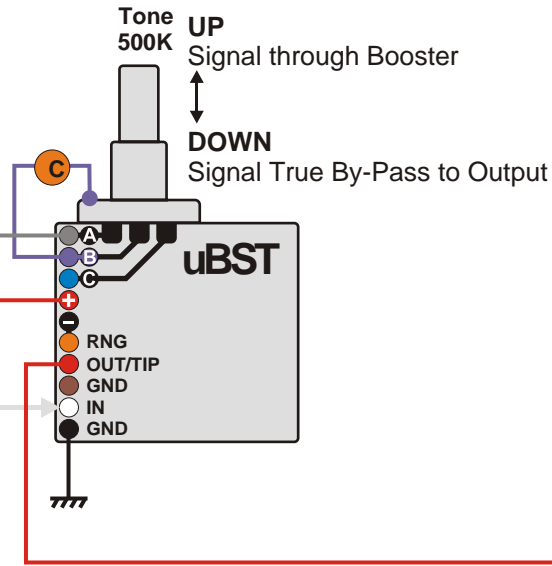
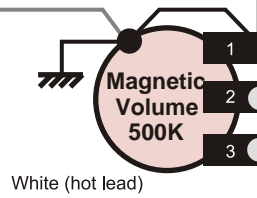

White (hot lead)

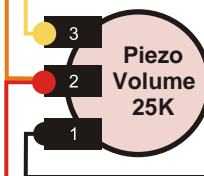

When instrument cable is inserted, Ring to Ground powers Booster circuit.